



*Vibration studies of a superconducting accelerating module at room temperature and at 4.5 K*

*Ramila Amirikas, Alessandro Bertolini, Wilhelm Bialowons*



## Introduction

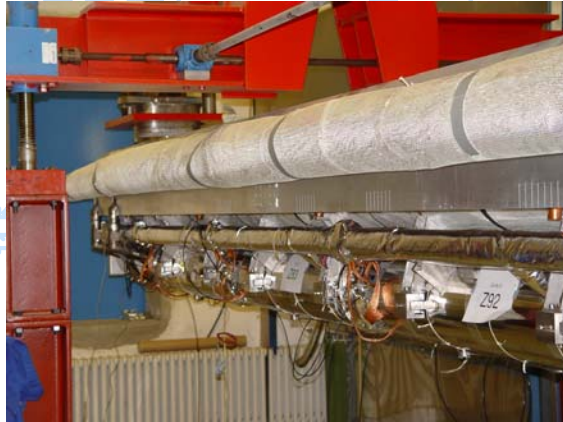

**Systematic approach** - from room temperature to 4.5K measurements (about 100 hrs of data), covering a large variety of conditions: cold mass during module assembly, 'warm' stand alone, on CMTB warm/cold.

Coming next -

- Study the influence of the **cryomodule support**.
- Study the behavior of a **string of cryomodules** in FLASH with implications for mechanical design and beam dynamics.

**Transfer function measurement** using inertial sensors and the ground vibrations as broadband excitation source (quite powerful in Hamburg...), - site independent characterization of the module stability providing a usable input for the ILC and XFEL module design (our data are now being used by FNAL (M.McGee) to validate the ANSYS model of Type-IV cryomodule).

Vibration studies on a Type III cryomodule at room temperature and at 4.5K - Introduction II-

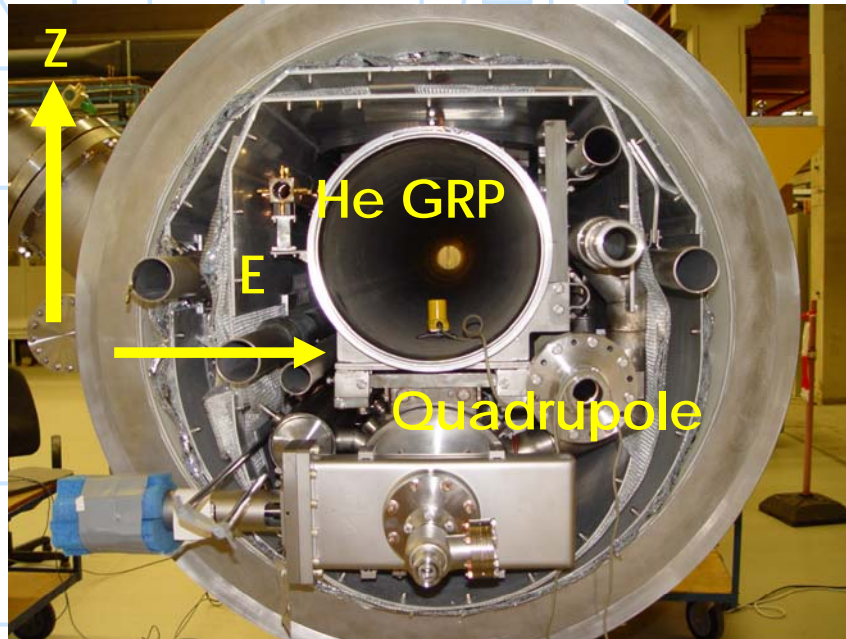

Some definition

$x(t), y(t)$	time series of length T, N points each
$X(v_i), Y(v_i)$	FFT
$\langle XX^* \rangle, \langle YY^* \rangle$	Estimated displacement power spectral density (PSD)
$\frac{ \langle XY^* \rangle ^2}{\langle XX^* \rangle \langle YY^* \rangle}$	Coherence
$\sqrt{\frac{ \langle XY^* \rangle }{\langle XX^* \rangle}}$	Transfer function amplitude
$\sqrt{\frac{1}{T} \sum_{i=k}^{N/2} \langle XX^* \rangle(v_i)}$	Integrated RMS amplitude at frequency $v_k$

Sensors

	CMG-6TD	geophone
n.axis	triaxial	single axis
frequency range	0.033-80 Hz	1.7-350 Hz
accuracy	0.5%	3%
rms noise >1Hz	<0.02 nm	2 nm

Module 6 room temperature measurements - quadrupole support stability -

Type III design very stiff as expected with no internal resonances up to 100 Hz both in horizontal and in vertical.

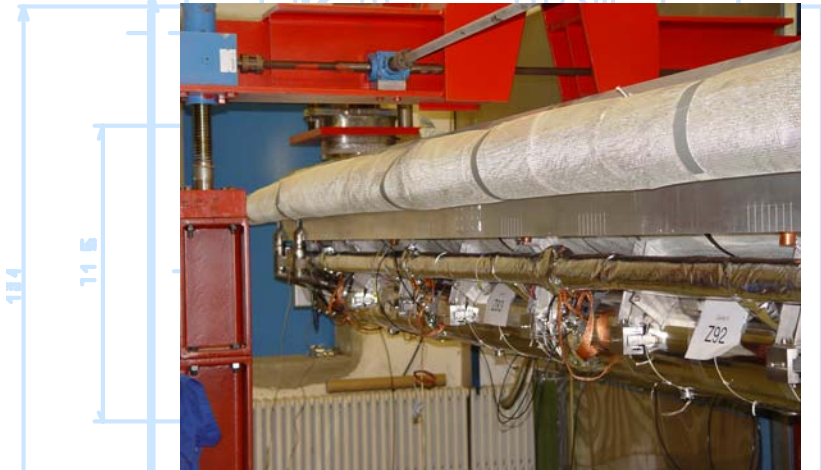

Module 6 cold mass on the assembly stand in DESY Hall III

Horizontal transverse / CM assembly stand

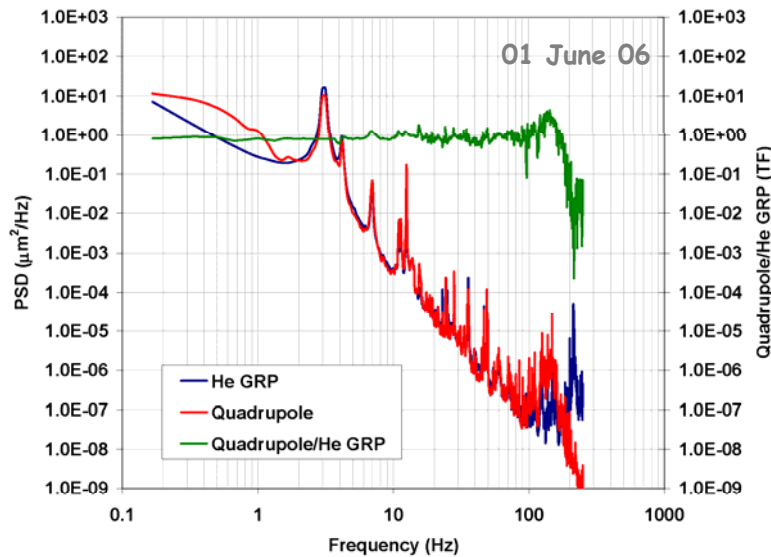

Vertical / Module 6 on CMTB

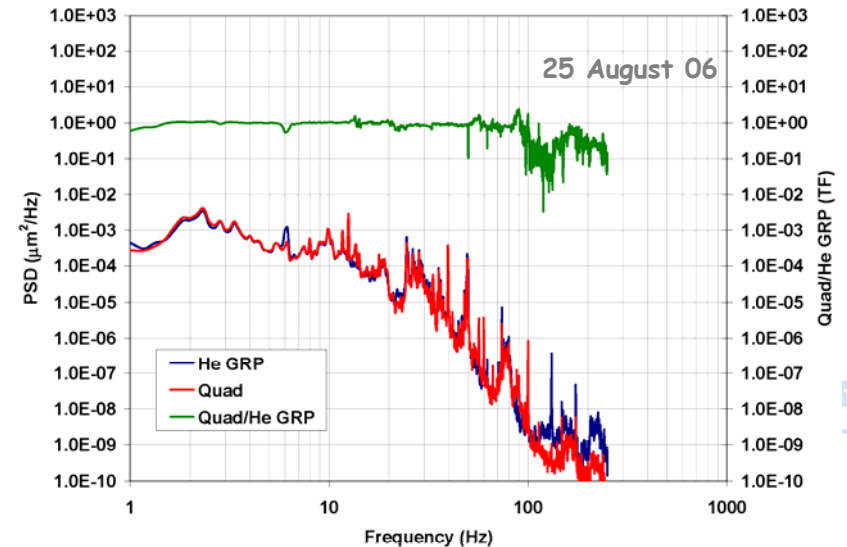

Horizontal transverse / Module 6 on CMTB

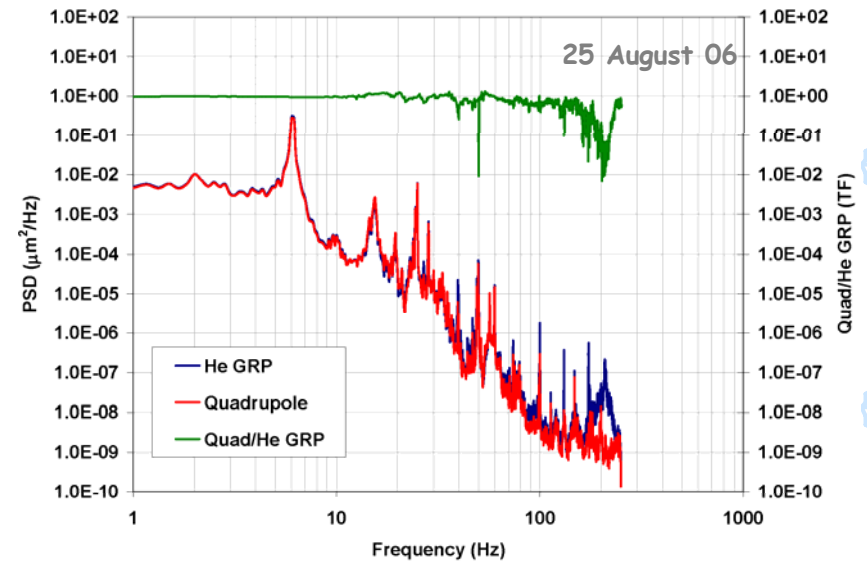

Module 6 room temperature measurements - vessel top / quadrupole transfer function

Horizontal / Module 6 on CMTB

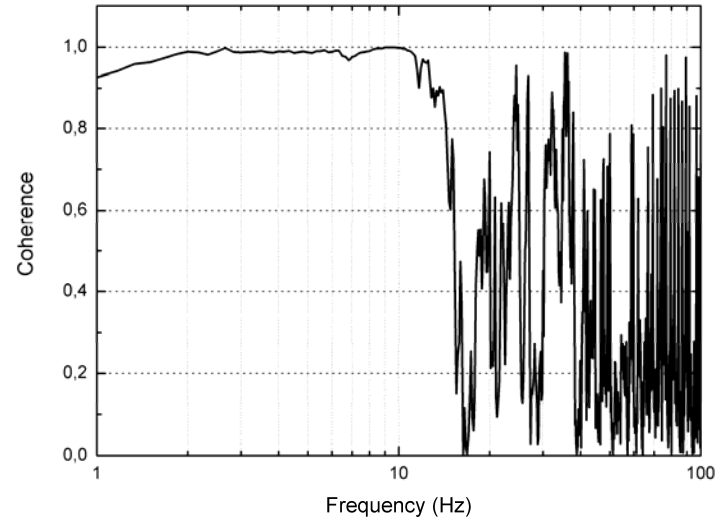
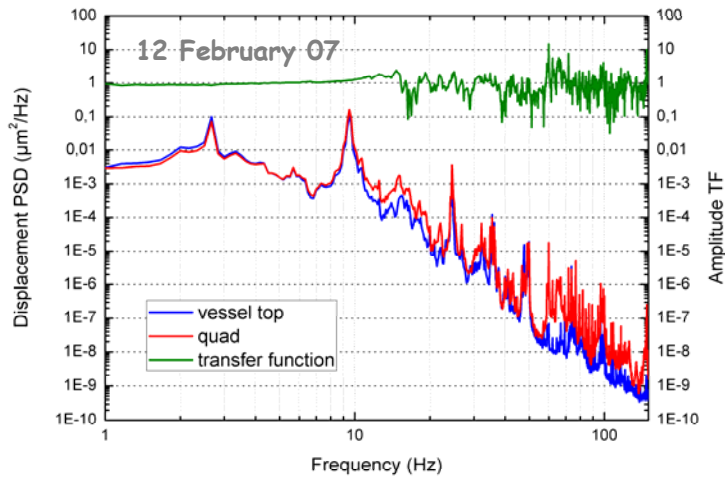

The measurement is limited by the effect of the cryostat support to  $\sim 40$  Hz in horizontal and to  $\sim 70$  Hz in vertical. In this range no resonance pattern was found in the TF confirming the reliability of the CM inner layout.

Vertical / Module 6 on concrete blocks

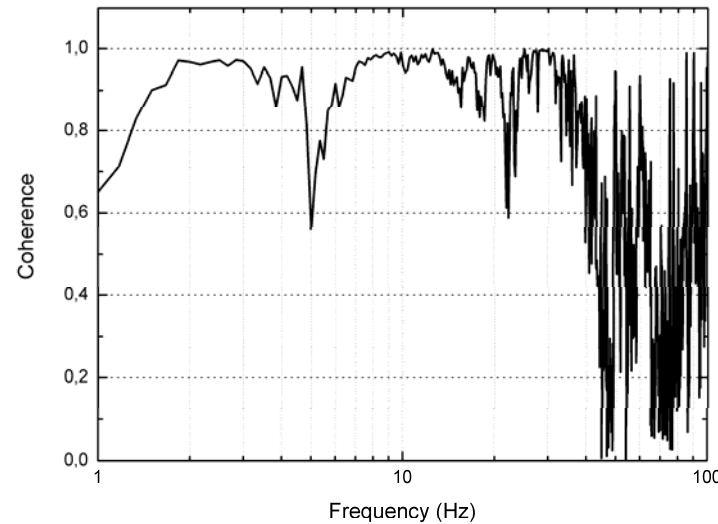
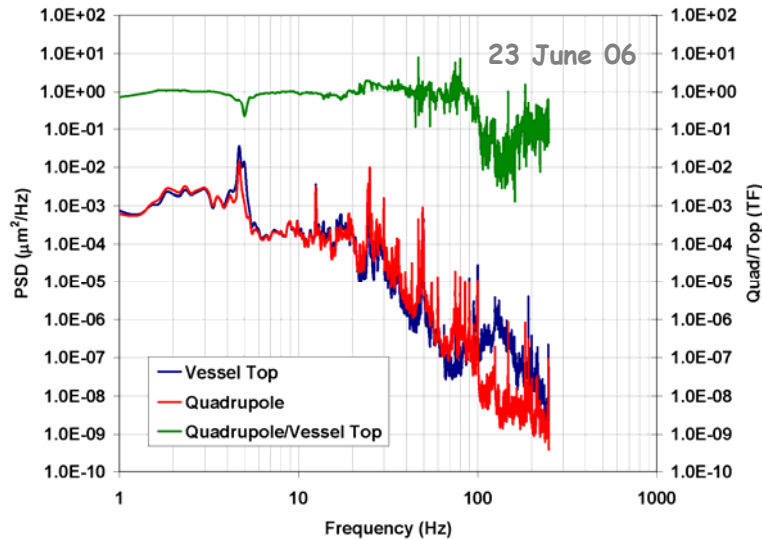

Module 6 room temperature measurements - effect of the cryostat support -



Hall III



CMTB-installation



CMTB-with endcaps

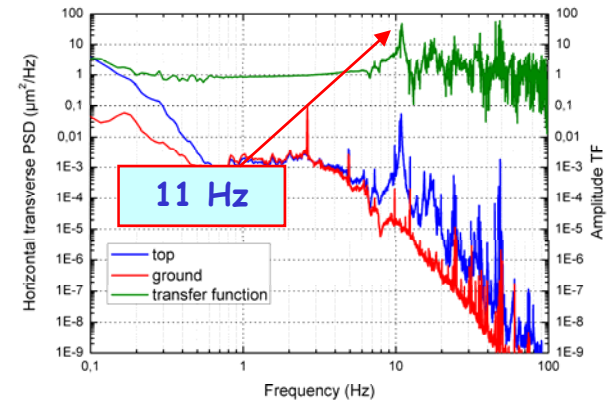
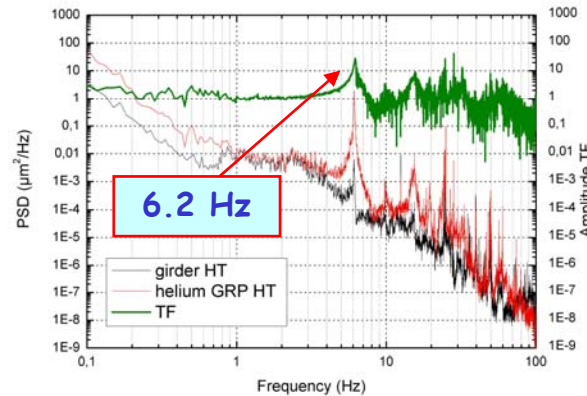
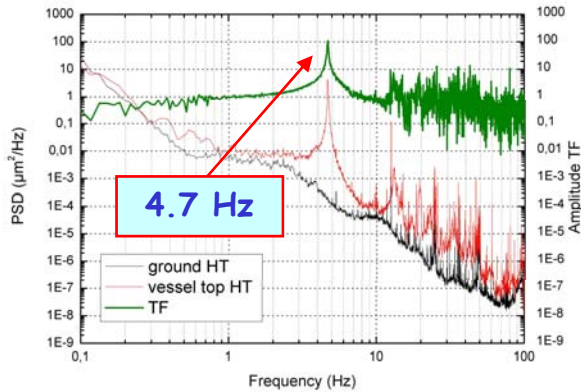

Effect of the support configuration+boundary conditions (pipe weldings+bellows) on the lowest frequency horizontal transverse mode with the clear stiffening after pipe weldings and closing the bellows

The cryostat on its support system behaves like a compound pendulum with normal modes (rocking+translational) at low frequencies that dominates the RMS amplitude together with technical noise sources. At present the support design looks the most relevant engineering issue to ensure dynamic stability to the cryomodule.

# Module 6 room temperature measurements - stability along the module length I-

Along the He GRP with geophones /Module 6 on blocks - RMS comparison

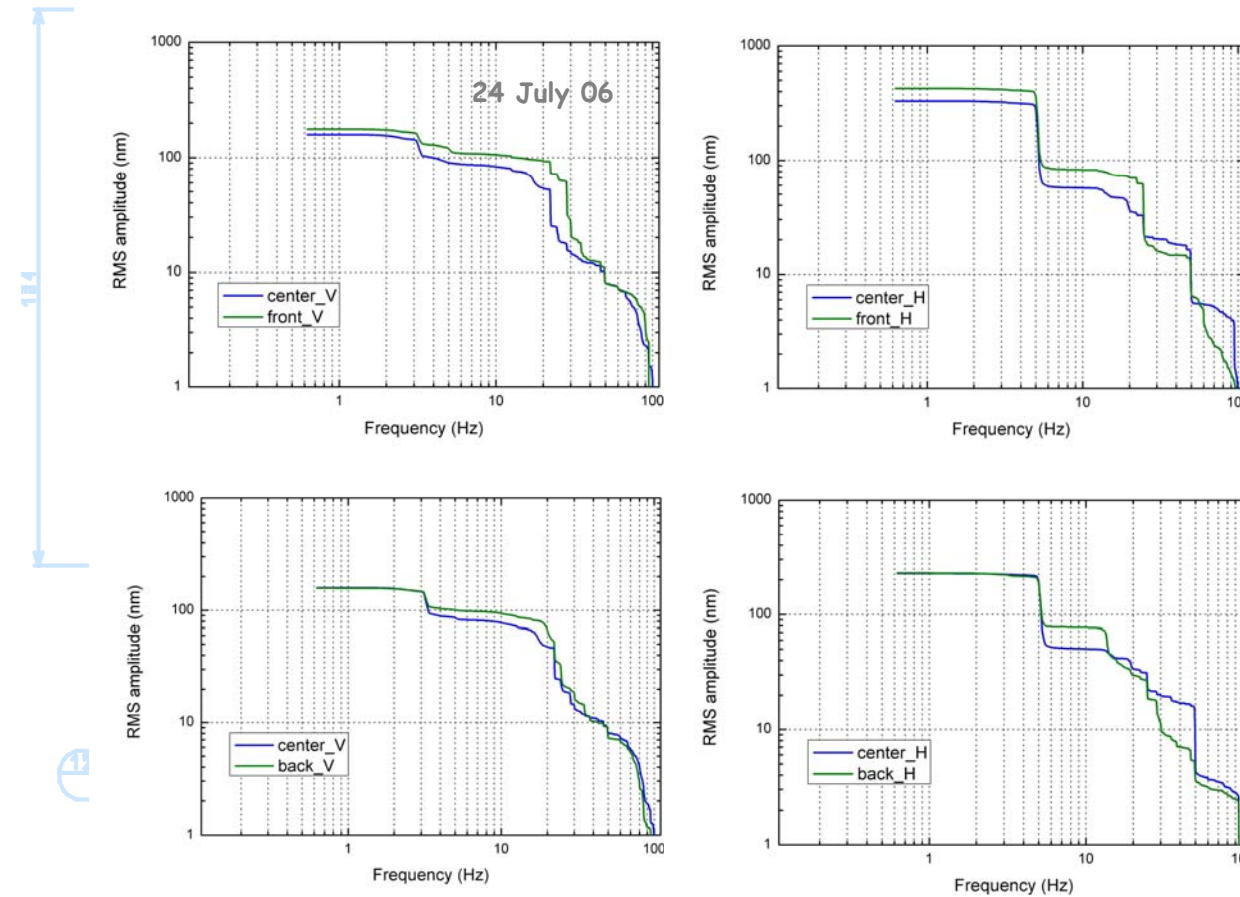

Sync\_Vert\_GRP RMS (nm)

	>2Hz	>10Hz
center V	156 -	84 -
front V	174 +12%	106 +26%
center V	156 -	78 -
back V	156 +0%	94 +21%

Sync\_Hor\_GRP RMS (nm)

	>2Hz	>10Hz
center H	329 -	57 -
front H	423 +28%	82 +44%
center H	226 -	50 -
back H	227 +0%	77 +54%



Geophones were placed on quad end, on the center and on the back end of the He GRP. The same measurement was repeated on the vessel top with seismometers.

### Comment

RMS larger at the end

Vertical: +23% @10Hz -believable

Horizontal: +50% @10Hz - not

believable (overestimated) because

the signal are not coherent in that

region due to the support system.

More measurement needed.

Module 6 room temperature measurements - stability along the module length II-

Module 6 on CMTB - with more realistic installation almost no difference between center and module ends ...

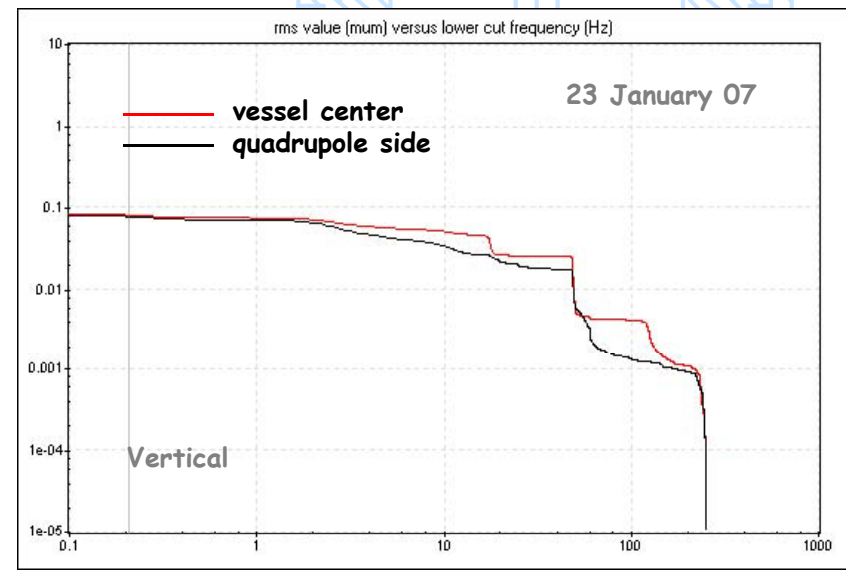
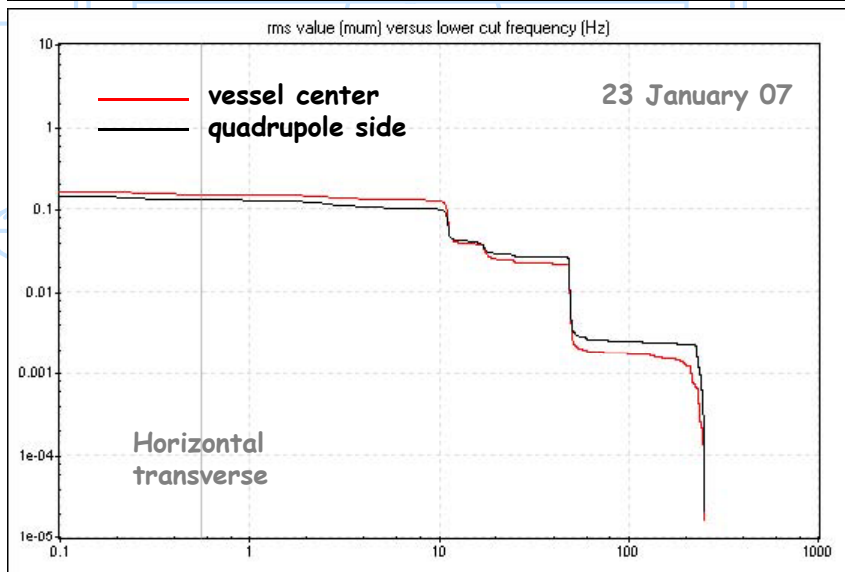
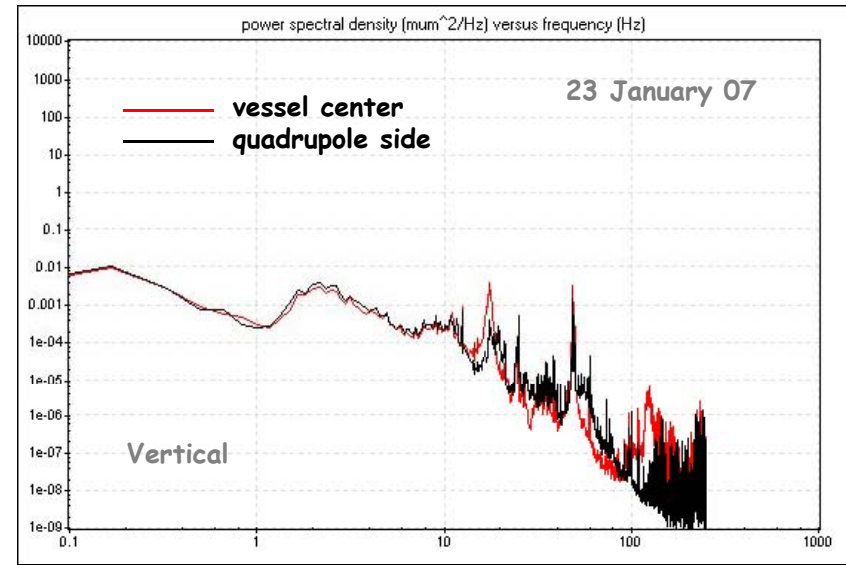
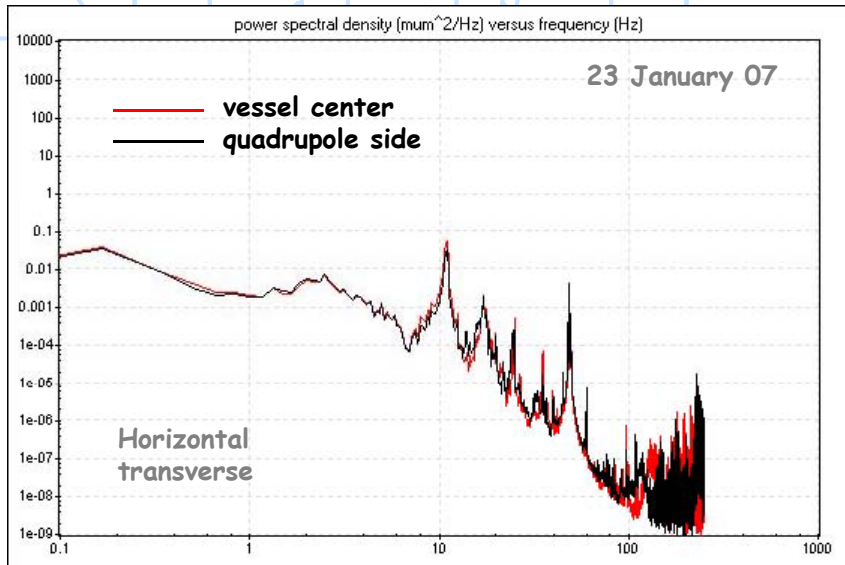



### Test geophone behaviour at 4.5 K

- on-board seismic sensor with adequate noise level down to below 1 Hz potentially available for quad and cavities.
- behaviour unknown, never been tested by the manufacturer in these extreme conditions, the company recommends use of the device down to  $-40^{\circ}\text{C}$ , only one cryogenic application cited in literature.
- the very robust and mature (~30 years) design was encouraging and the test has been successful.

### Quadrupole vibration measurements at 4.5 K

- chance to give a first quantitative (from 1 Hz) evaluation of the impact of cryogenic plant and high gradient RF on the quadrupole vibration level, not possible so far because of the lack of sensitivity of cooled piezo accelerometers below  $\sim 10$  Hz



Module 6 on CMTB: quadrupole side

Geophones installed on the quad front face



Cold quadrupole vibration measurements on Module 6 at CMTB - experiment setup -



Vessel top vertical sensor (horizontal transverse companion not visible)



Ground vertical sensor (horizontal transverse companion not visible)

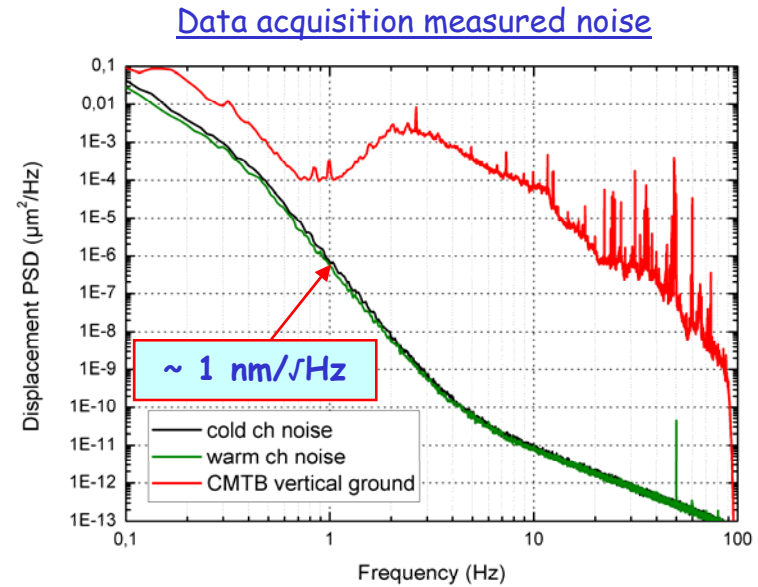

Cold/warm Geophone

20 m cable

Test amplifier

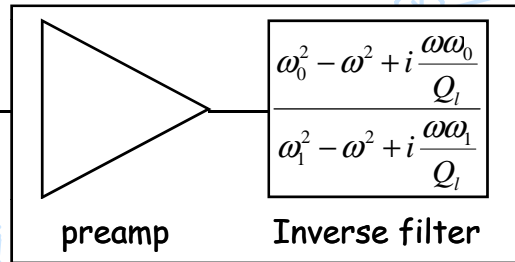

Inverse filtering provides equalization of the geophone response down to 0.5 Hz

24 bit Güralp digitizer

200 S/s

Laptop  
Data logging  
Spectral analysis (FFT, PSD, Coherence, RMS, Transfer function, etc.)

**Remote calibration method**

Accurate remote calibration possible using the signal cable itself; no access to the sensor is necessary. By measuring the electrical impedance vs frequency at the output terminals of the sensor we have access to both electrical and mechanical parameters. Only the suspended mass has to be known.

$$Z_E(\omega) = R_{coil} + j\omega L + \frac{j\omega G^2 / m}{\omega_0^2 - \omega^2 + j\frac{\omega\omega_0}{Q_l}}$$

Geophone equivalent impedance

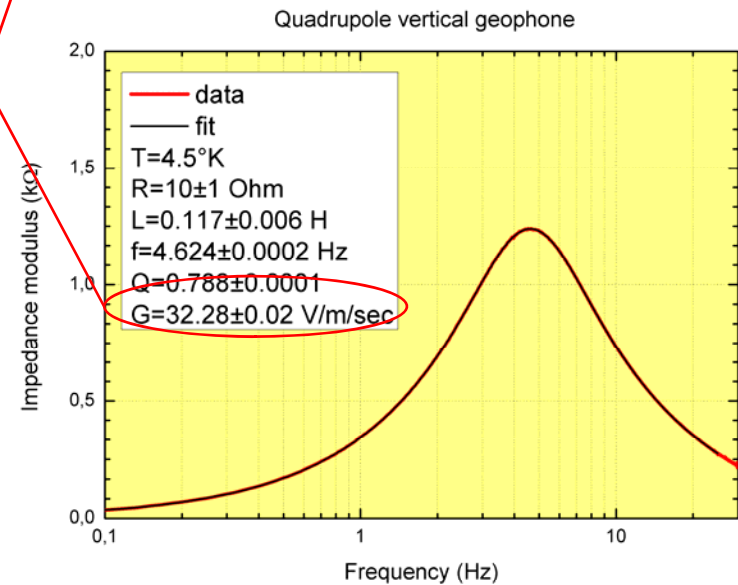
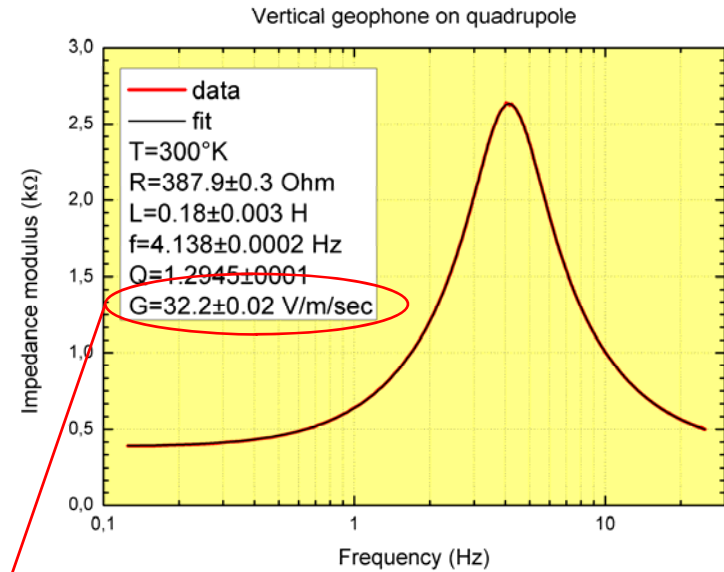

No loss of sensitivity at liquid helium temperature !!

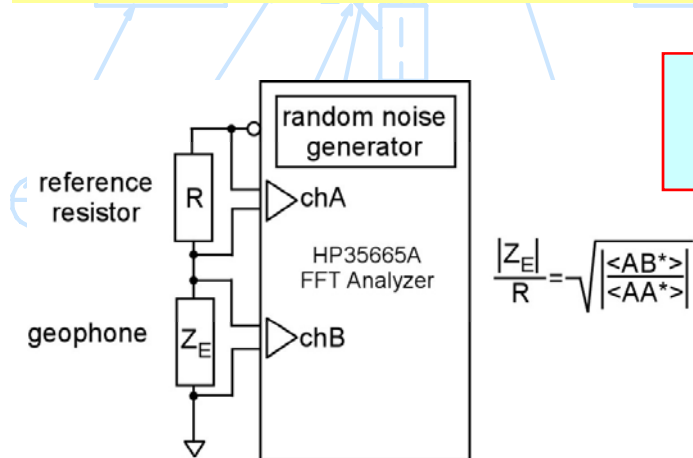

Block diagram of the calibration procedure

Cold quadrupole vibration measurements on Module 6 at CMTB - reference warm measurement I-

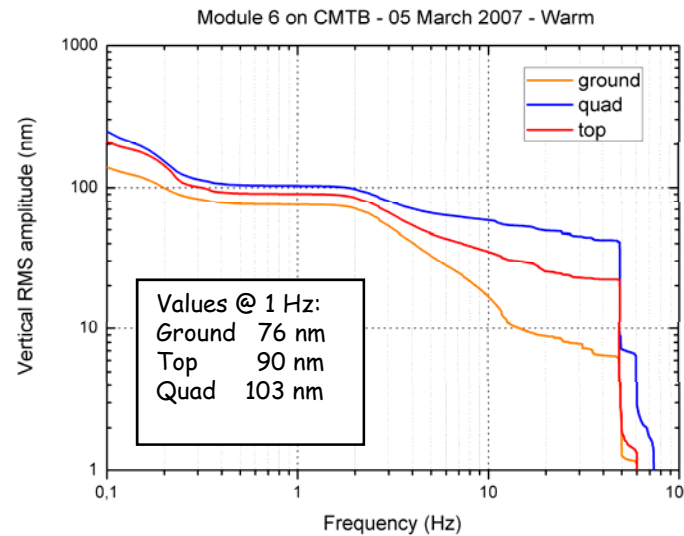
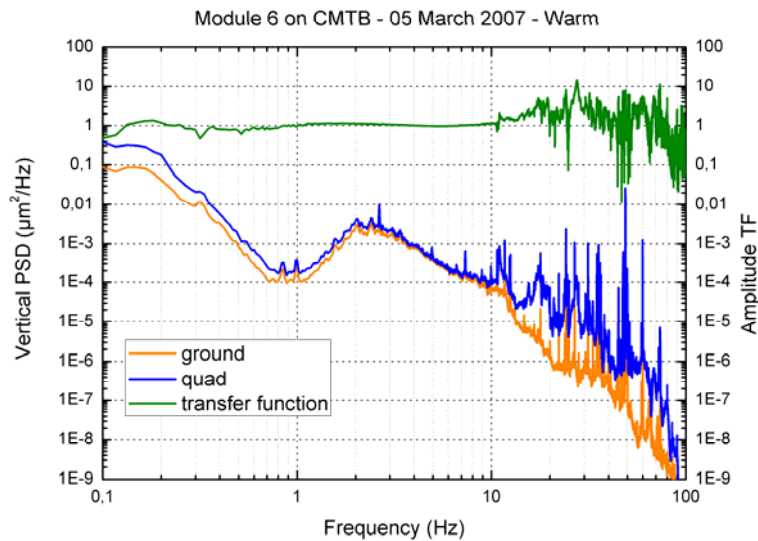
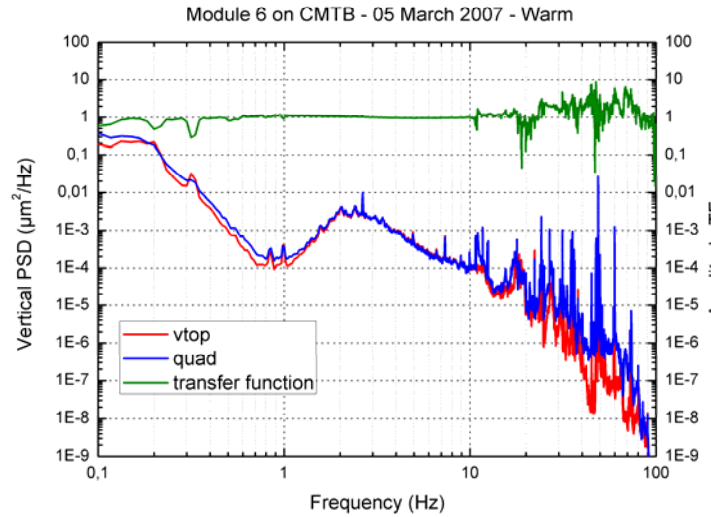
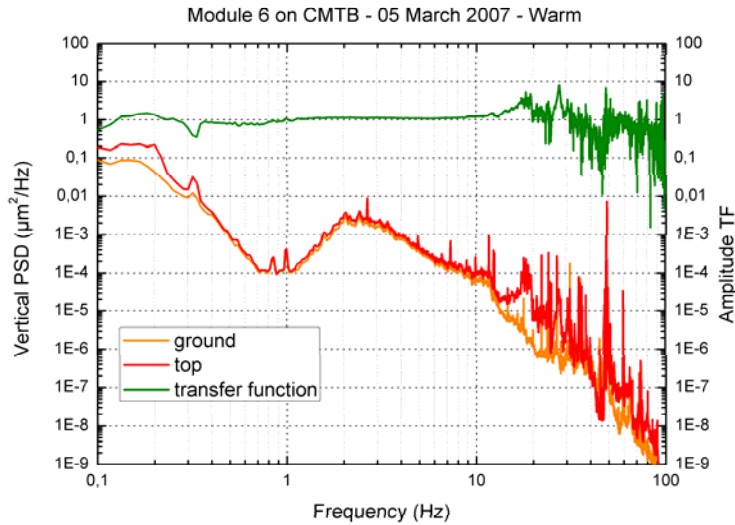

**General features of the spectra**  
 Typical DESY site spectrum at frequencies 1-10 Hz. Technical noise dominating > 20 Hz; strongest peak from the insulation vacuum pump at 48 Hz. Effect of the cryostat support well visible: coupling with rocking modes at 11 Hz and 18 Hz and vertical resonance at 27 Hz; quad vs top transfer function almost flat below 40 Hz.

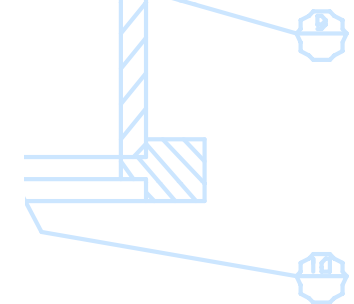

\*2 hrs data measured at the end of the 10th thermal cycle

### RMS analysis

In the low frequency band the quadrupole motion tracks the ground vibration level. Slight amplitude differences are related mainly to the mechanical transfer function of the module on its support.

Module 6 on CMTB - 05 March 2007 - Warm

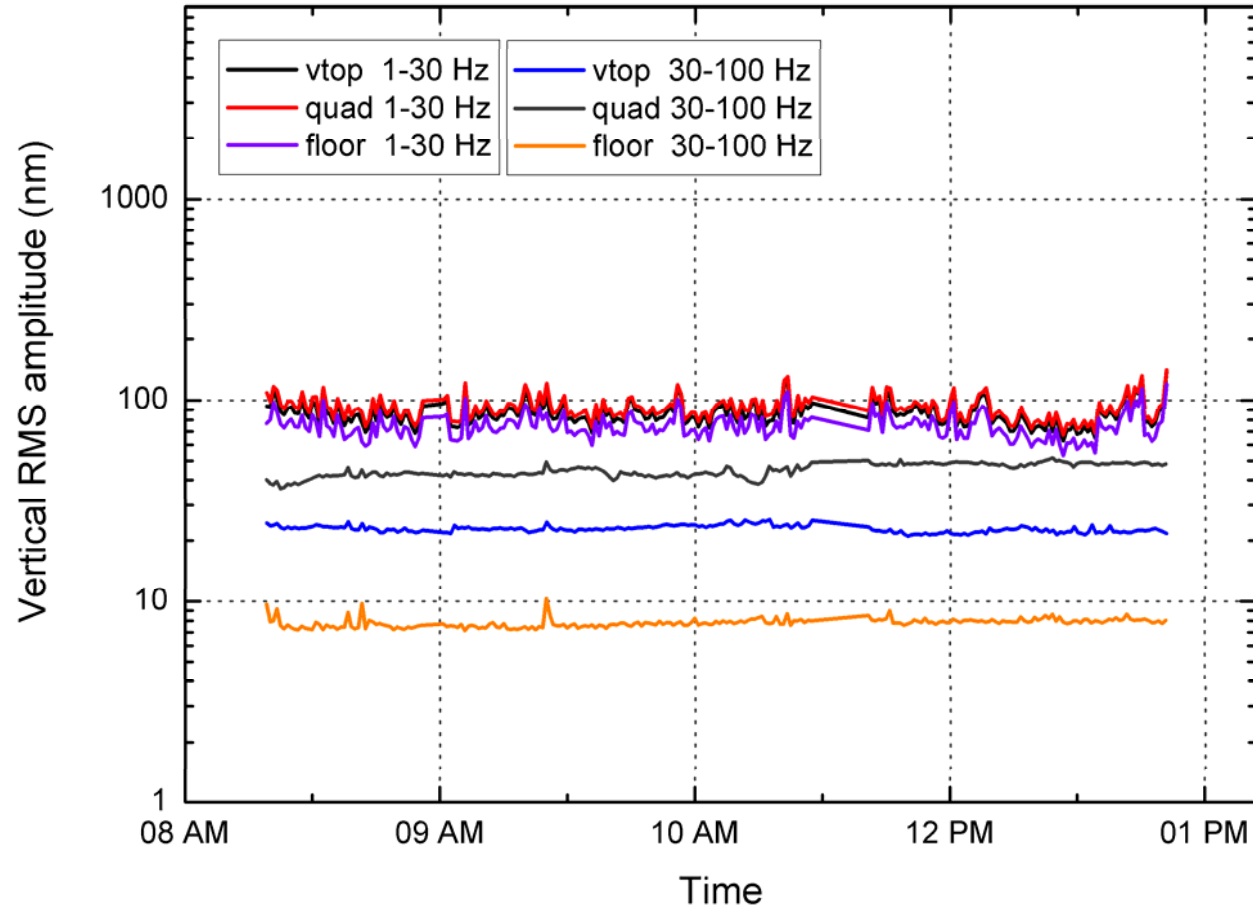

## Cold quadrupole vibration measurements on Module 6 at CMTB - cold measurement I-

### RMS analysis

Ground motion tracking confirmed at low frequencies, with ~10% quad/gnd and top/gnd rms ratios. No difference with warm operation.

The refrigeration system doesn't affect the quadrupole vertical stability at low frequency ( $f < 30$  Hz).

Large vibrations due to the onset of a strong peak above 30 Hz. The peak shows slow frequency changes from 30.1 Hz up to 32 Hz. The amplitude can vary from 200 nm up to  $> 1 \mu\text{m}$ . Not a mechanical resonance of the cryomodule; not visible at all in the quad vs top transfer function.

Module 6 on CMTB - 08 March 2007 - 2°K / no RF

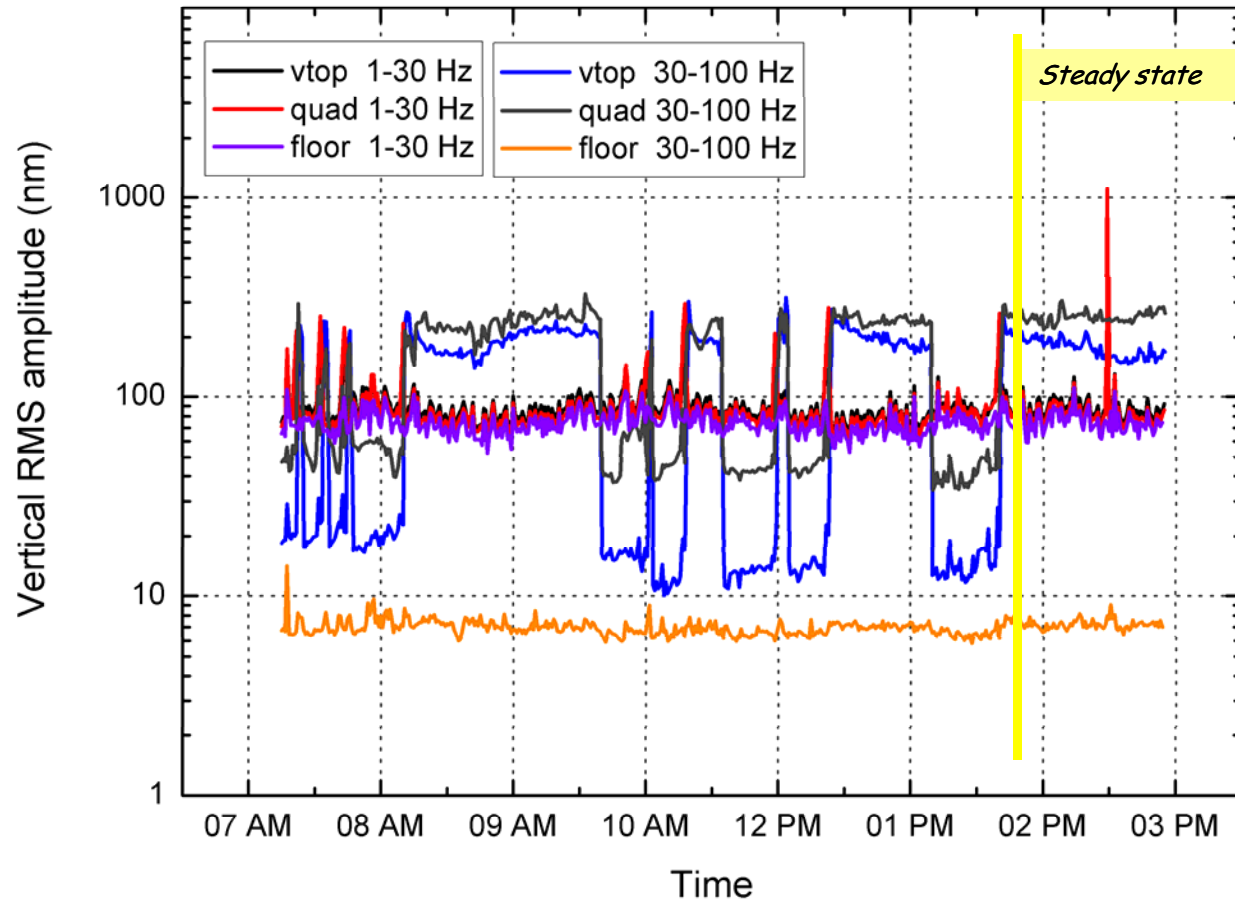

\*data measured at the end of the 11th cooldown

## Cold quadrupole vibration measurements on Module 6 at CMTB - cold measurement II-

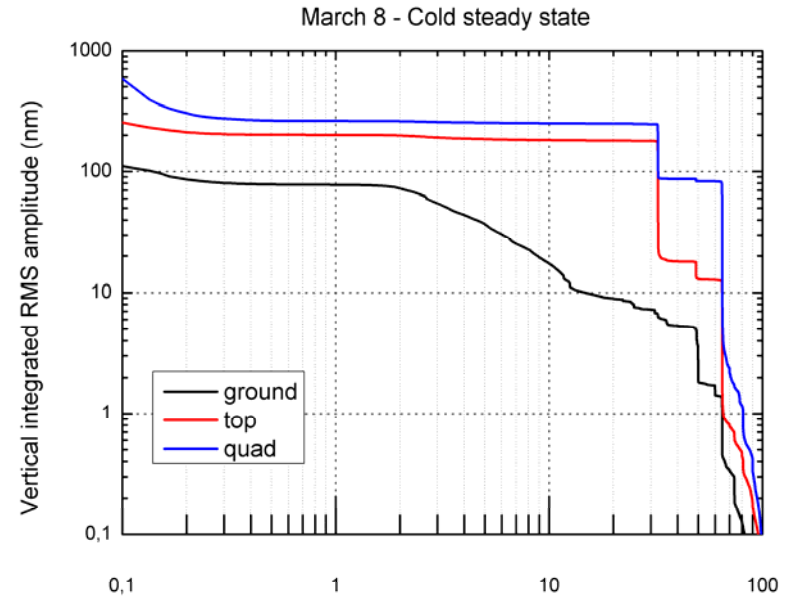
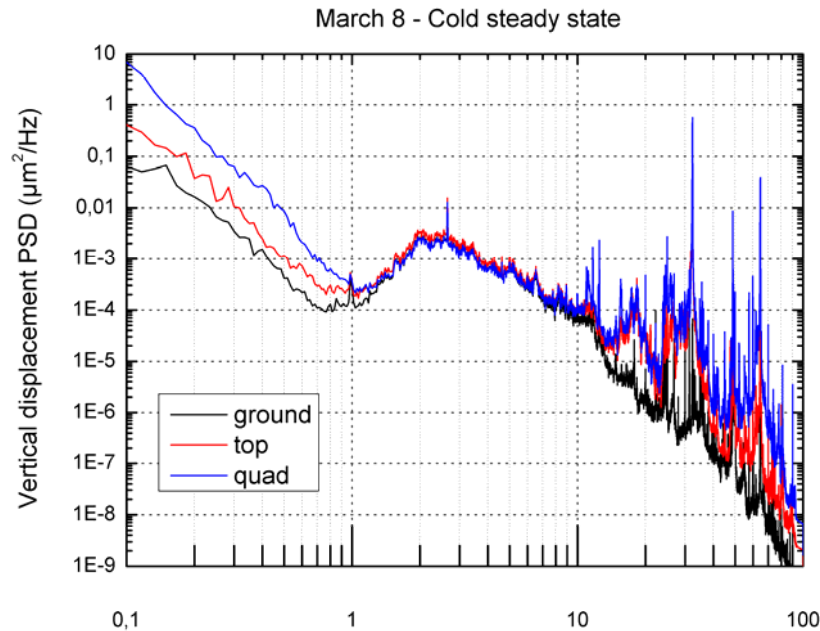

### 08 March in steady state

Quad LHe inlet flow: 8.2 g/sec  
 Quad LHe inlet valve: 20%  
 Cavity 2K Inlet valve: 56%  
 Cavity 2K He flow: 5 g/sec  
 Cavity 2K He reservoir level: 43%

### Comments

Peak frequency  $\sim 32\text{Hz}$  in this case. The integrated RMS @1 Hz values are 78 nm (ground), 206 nm (vessel top), 260 nm (quad). The peak is also visible in the ground spectrum. A strong correlation between the average vibration level and the settings of the LHe forward line inlet valve has been found. All the clues point to a **thermal acoustic oscillation** generated in the diagnostic pipe immediately upward of the same valve.

Cold quadrupole vibration measurements on Module 6 at CMTB - cold measurement III-

Module 6 on CMTB - 01 March -High gradient

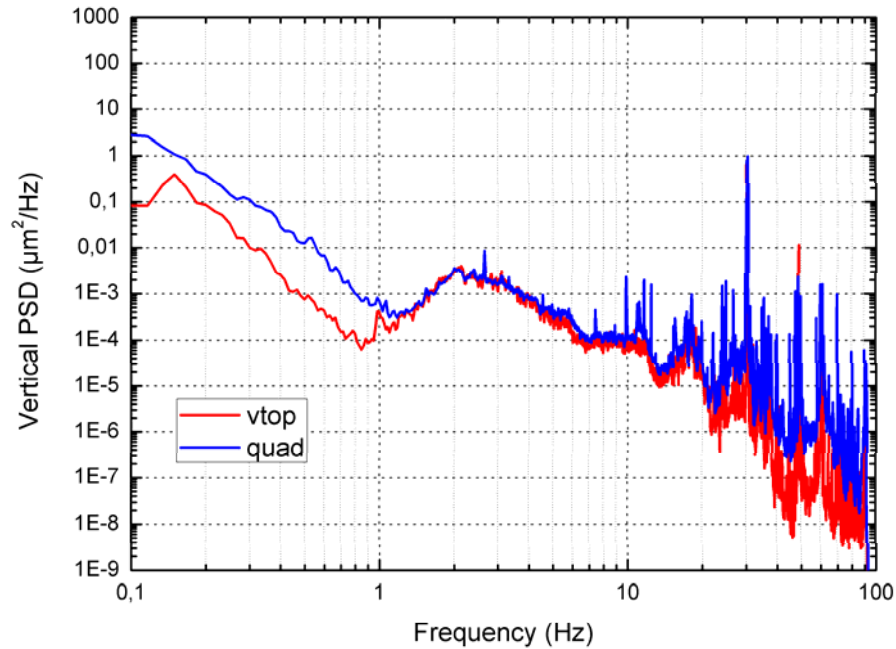

01 March High power RF  
 Quad LHe inlet flow: 5.3 g/sec  
 Quad LHe inlet valve: 100%  
 Cavity 2K Inlet valve: 50%  
 Cavity 2K He flow: 3.8 g/sec  
 Cavity 2K He reservoir level: 43%

\*1.5 hrs data taken between 6:30 and 8 PM;  
 klystron at 10 Hz, ~27 MV/m average gradient

**Comments**

Peak frequency ~ 30.6 Hz in this case. The average integrated RMS @1 Hz values are 50 nm (ground), 215 nm (vessel top), 500 nm (quad).

Larger RMS have been measured even with RF off or during LLRF tests. The RF doesn't affect the vibration stability of the module.



### Geophone test at 4.5K

- classic 4.5 Hz industrial geophone can operate at 4K without any loss of sensitivity
- remote high accuracy calibration procedure demonstrated

### Quadrupole vibration measurements at 4.5K

- low frequency (1-100 Hz) quadrupole vertical stability is not affected by high gradient RF operation
- quadrupole vertical stability is not affected by the refrigeration system at frequencies up to 30 Hz; results not conclusive at higher frequency because of the onset of a thermal acoustic oscillation in a diagnostic pipe upward of the LHe forward line (preliminary result).

### Next

- investigation will continue on Module 5 (Type III) on the CMTB, starting from end next week, and in the FLASH linac where we could monitor continuously a string of 3 Type III cryomodules during normal operation with geophones (from August)
- Warm/cold test on Module 8 (Type III+) with both geophones and Doppler velocimeter. Possible a more detailed test on stability along the module with geophones aboard the cold mass at different positions?

\*Special thanks to: DESY MKS crew for the continuous support, Markus Kubczigk and Heiko Ehrlichmann for providing software tools